

# EXPLODED DRAWING A—Model No. F604.0

R0909A

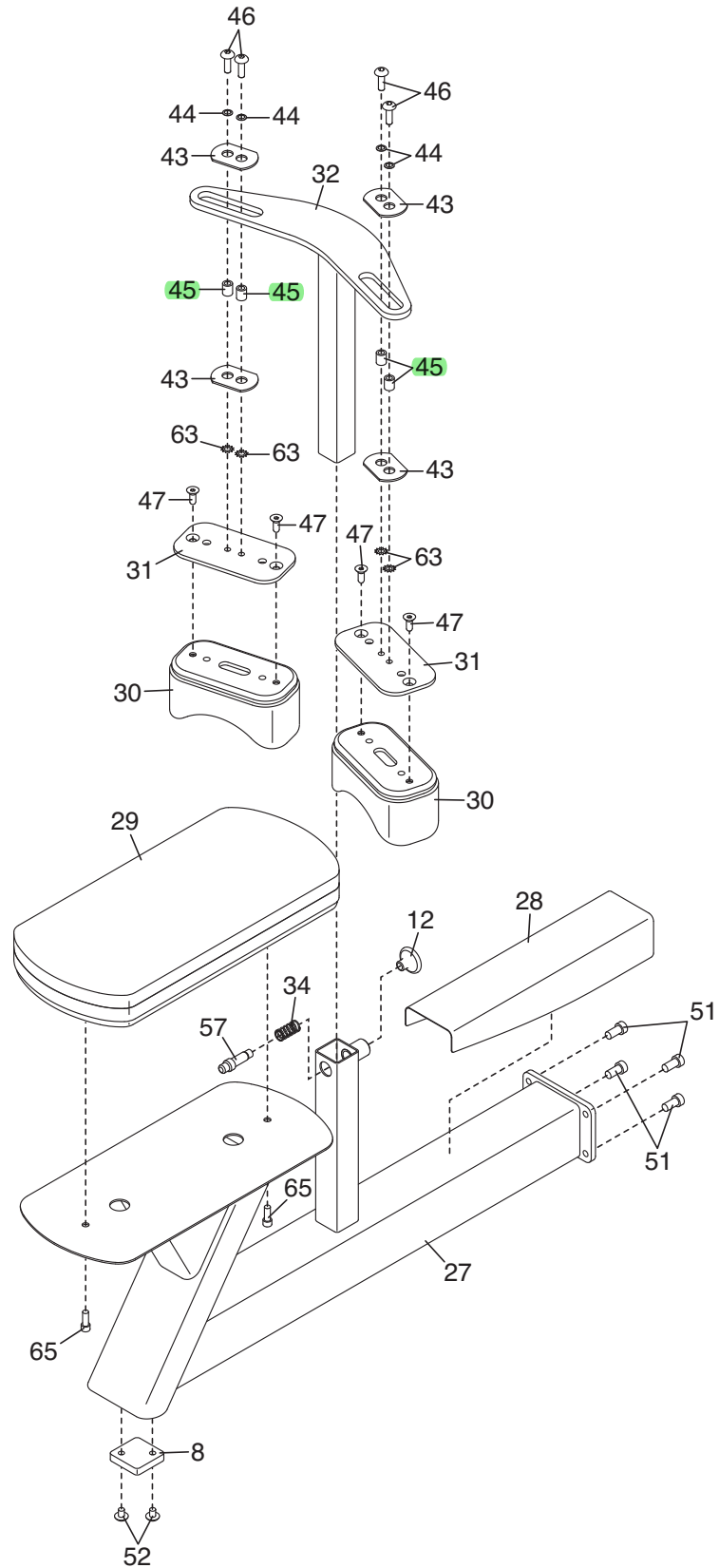

# EXPLODED DRAWING B—Model No. F604.0

R0909A

